

Fixed-Focus Lens

This fixed-focus lens is designed for use with Panasonic's applicable projectors. This lens is an ultra-short focal length lens which uses a mirror.

NOTE: The lens cannot be used by itself. It must be mounted onto the specified Panasonic DLP™ projector.

Specifications

F value:	2.5		
Focal length (f):	7.5 mm		
Lens shift:	Capable (Adjustment range is limited. Lens shift is possible with models other than the PT-DS20K/DS20K2/DS12K/RS11K.)	Vertical shift	Horizontal shift
		up: 10% down: 0%	left: 12%; right: 16%
		up: 5% down: 0%	left: 6%; right: 6%
		up: 13% down: 0%	left: 12%; right: 14%
		up: 18% down: 0%	left: 13%; right: 27%
Dimensions (W x H x D):	448.5mm x ø154 mm (17-21/32 x ø6-1/16 inches)		
Weight:	Approx 6.5 kg (14.3 lbs)		
Applicable projector:	[Group A] PT-DZ21K/DZ21K2/DS20K/DS20K2/DW17K/DW17K2/DZ16K/DZ16K2		
	[Group B] PT-DZ13K/DS12K/DW11K/DZ10K/DZ8700/DZ110K/DS8500/DS1100K/DW8300/DW90K		
	[Group C] PT-RZ12K/RS11K PT-RQ13K		

Dimensions

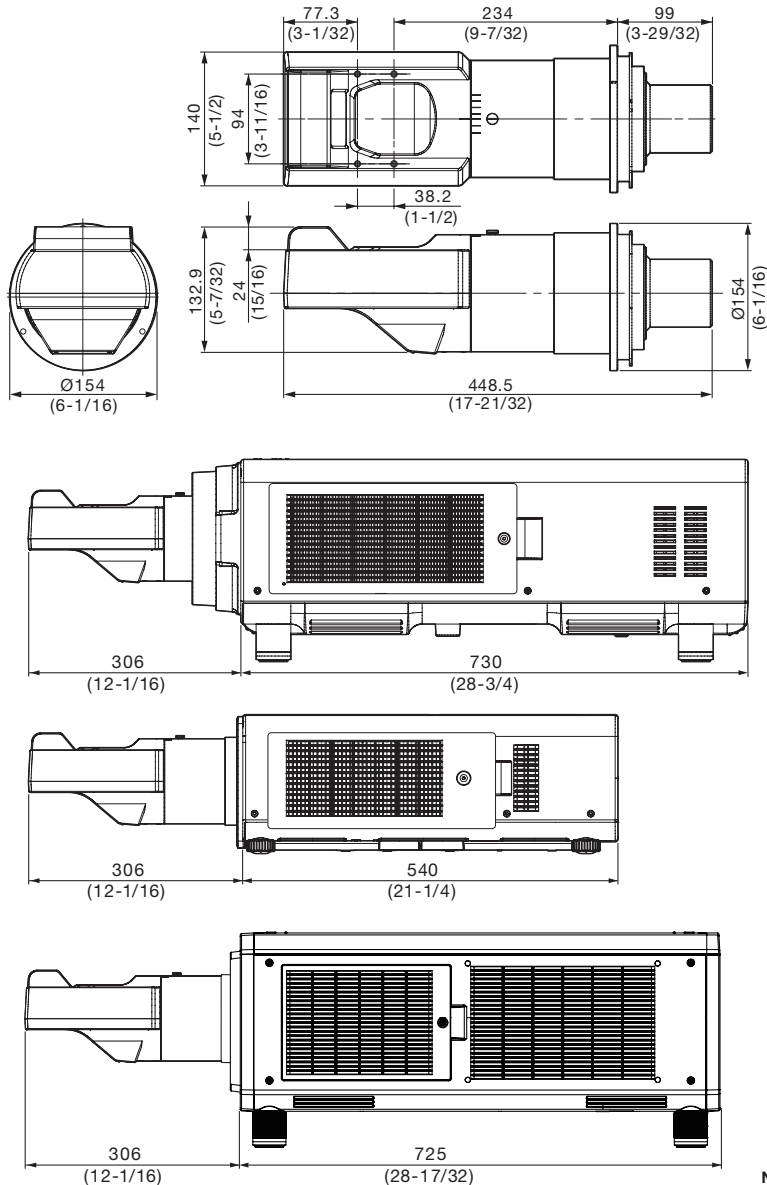

unit : mm (inch)

NOTE: This illustration is not drawn to scale.

DLP is a trademark of Texas Instruments. Weights and dimensions shown are approximate. Specifications subject to change without notice.

Fixed-Focus Lens

ET-D75LE90 Projection Distance Table

PT-RQ13K

16 : 10 (WUXGA ; 1920 × 1200)

Unit : meters

Throw ratio				Ultra-short focal length lens ET-D75LE90 Close-up system dimensions							
Diagonal image size (Inches)	Diagonal image size (m)	Height (SH)	Width (SW)	Projection distance (From mirror reflective surface to screen) (L1)	From tip of lens to screen (L2)	From front of set to screen (L3)	From rear of set to screen (L4)	From top of set to bottom edge of screen (A1)		From bottom of set to bottom edge of screen (A2)	
								Min	Max	Min	Max
120	3.05	1.62	2.58	1.01	1.04	0.73	0.01	0.27	0.42	0.59	0.74
150	3.81	2.02	3.23	1.26	1.29	0.98	0.26	0.37	0.56	0.69	0.88
200	5.08	2.69	4.31	1.67	1.70	1.39	0.67	0.53	0.79	0.86	1.11
250	6.35	3.37	5.38	2.08	2.11	1.81	1.08	0.70	1.01	1.02	1.34
300	7.62	4.04	6.46	2.50	2.52	2.22	1.49	0.86	1.24	1.19	1.57
350	8.89	4.71	7.54	2.91	2.94	2.63	1.91	1.03	1.47	1.35	1.79
400	10.16	5.38	8.62	3.32	3.35	3.04	2.32	1.19	1.70	1.52	2.02
500	12.70	6.73	10.77	4.15	4.17	3.87	3.14	1.52	2.15	1.85	2.48
600	15.24	8.08	12.92	4.97	5.00	4.69	3.97	1.85	2.61	2.17	2.93

Unit : feet

Throw ratio				Ultra-short focal length lens ET-D75LE90 Close-up system dimensions							
Diagonal image size (Inches)	Diagonal image size (m)	Height (SH)	Width (SW)	Projection distance (From mirror reflective surface to screen) (L1)	From tip of lens to screen (L2)	From front of set to screen (L3)	From rear of set to screen (L4)	From top of set to bottom edge of screen (A1)		From bottom of set to bottom edge of screen (A2)	
								Min	Max	Min	Max
120	3.05	5.3	8.5	3.3	3.4	2.4	0.0	0.9	1.4	1.9	2.4
150	3.81	6.6	10.6	4.1	4.2	3.2	0.8	1.2	1.8	2.3	2.9
200	5.08	8.8	14.1	5.5	5.6	4.6	2.2	1.7	2.6	2.8	3.6
250	6.35	11.0	17.7	6.8	6.9	5.9	3.5	2.3	3.3	3.3	4.4
300	7.62	13.2	21.2	8.2	8.3	7.3	4.9	2.8	4.1	3.9	5.1
350	8.89	15.5	24.7	9.5	9.6	8.6	6.3	3.4	4.8	4.4	5.9
400	10.16	17.7	28.3	10.9	11.0	10.0	7.6	3.9	5.6	5.0	6.6
500	12.70	22.1	35.3	13.6	13.7	12.7	10.3	5.0	7.1	6.1	8.1
600	15.24	26.5	42.4	16.3	16.4	15.4	13.0	6.1	8.6	7.1	9.6

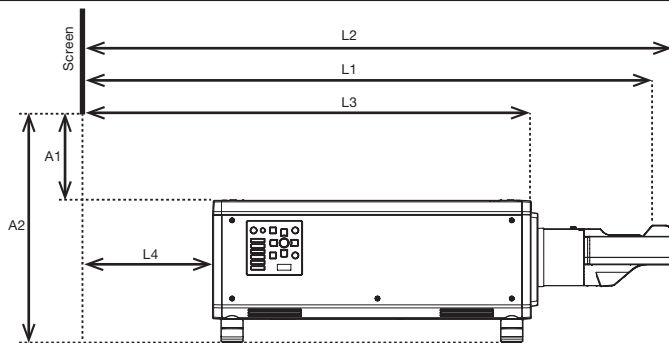

- L1: Projection distance (from screen to mirror reflective surface)
- L2: From screen to tip of lens
- L3: From screen to front of set
- L4: From screen to rear of set
- A1: From bottom edge of screen to top of set
- A2: From bottom edge of screen to bottom of set

Projection Distance Calculation Table

Screen aspect ratio 16:10

Projection distance calculation formula

$$L1 \text{ (m)} = 0.0083 \times \text{Diagonal image size (inches)} + 0.02$$

Calculation formula for distance from top of set to bottom edge of screen

RQ13K	Min. A1 (m) = 0.245 x SH - 0.128 Max. A1 (m) = 0.339 x SH - 0.128
-------	--

ET-D75LE90 Projection Distance Table

DZ21K/DZ21K2

16 : 10 (WUXGA ; 1920 × 1200)

Unit : meters

Ultra-short focal length lens ET-D75LE90 Close-up system dimensions											
Throw ratio				0.36:1	From tip of lens to screen (L2)	From front of set to screen (L3)	From rear of set to screen (L4)	From top of set to bottom edge of screen (A1)		From bottom of set to bottom edge of screen (A2)	
Diagonal image size (Inches)	Diagonal image size (m)	Height (SH)	Width (SW)	Projection distance (From mirror reflective surface to screen) (L1)				Min	Max	Min	Max
120	3.05	1.62	2.59	0.94	0.97	0.67	-0.06	0.26	0.34	0.55	0.63
150	3.81	2.02	3.23	1.18	1.20	0.90	0.17	0.35	0.46	0.64	0.75
200	5.08	2.69	4.31	1.56	1.59	1.28	0.55	0.50	0.65	0.79	0.94
250	6.35	3.37	5.39	1.95	1.97	1.67	0.94	0.66	0.84	0.95	1.13
300	7.62	4.04	6.46	2.33	2.36	2.05	1.32	0.81	1.03	1.10	1.32
350	8.89	4.71	7.54	2.72	2.74	2.44	1.71	0.97	1.22	1.26	1.51
400	10.16	5.39	8.62	3.10	3.13	2.82	2.09	1.12	1.41	1.41	1.70
500	12.70	6.73	10.77	3.87	3.90	3.59	2.86	1.43	1.79	1.72	2.08
600	15.24	8.08	12.92	4.64	4.67	4.36	3.63	1.74	2.17	2.03	2.46

Unit : feet

Ultra-short focal length lens ET-D75LE90 Close-up system dimensions											
Throw ratio				0.36:1	From tip of lens to screen (L2)	From front of set to screen (L3)	From rear of set to screen (L4)	From top of set to bottom edge of screen (A1)		From bottom of set to bottom edge of screen (A2)	
Diagonal image size (Inches)	Diagonal image size (m)	Height (SH)	Width (SW)	Projection distance (From mirror reflective surface to screen) (L1)				Min	Max	Min	Max
120	3.05	5.3	8.5	3.1	3.2	2.2	-0.2	0.9	1.1	1.8	2.1
150	3.81	6.6	10.6	3.9	4.0	2.9	0.6	1.1	1.5	2.1	2.5
200	5.08	8.8	14.1	5.1	5.2	4.2	1.8	1.6	2.1	2.6	3.1
250	6.35	11.0	17.7	6.4	6.5	5.5	3.1	2.2	2.8	3.1	3.7
300	7.62	13.3	21.2	7.6	7.7	6.7	4.3	2.7	3.4	3.6	4.3
350	8.89	15.5	24.7	8.9	9.0	8.0	5.6	3.2	4.0	4.1	5.0
400	10.16	17.7	28.3	10.2	10.3	9.3	6.9	3.7	4.6	4.6	5.6
500	12.70	22.1	35.3	12.7	12.8	11.8	9.4	4.7	5.9	5.6	6.8
600	15.24	26.5	42.4	15.2	15.3	14.3	11.9	5.7	7.1	6.7	8.1

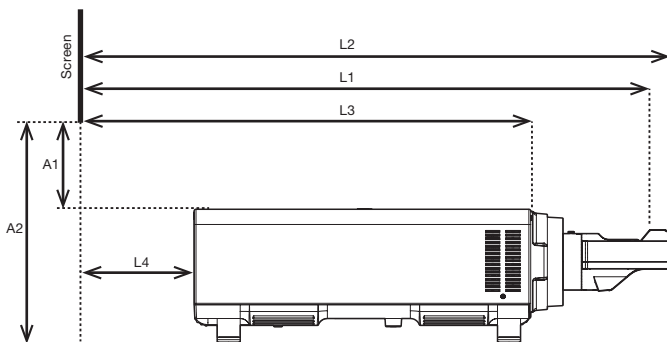

- L1: Projection distance (from screen to mirror reflective surface)
- L2: From screen to tip of lens
- L3: From screen to front of set
- L4: From screen to rear of set
- A1: From bottom edge of screen to top of set
- A2: From bottom edge of screen to bottom of set

Projection Distance Calculation Table

Screen aspect ratio 16:10

Projection distance calculation formula

$$L1 \text{ (m)} = 0.0077 \times \text{Diagonal image size (inches)} + 0.02$$

Calculation formula for distance from top of set to bottom edge of screen

DZ21K/DZ21K2	Min. A1 (m) = 0.000229 × SH - 0.114 Max. A1 (m) = 0.000283 × SH - 0.114
--------------	--

ET-D75LE90 Projection Distance Table

RZ12K

16 : 10 (WUXGA ; 1920 × 1200)

Unit : meters

Ultra-short focal length lens ET-D75LE90 Close-up system dimensions											
Throw ratio				0.36:1	From tip of lens to screen (L2)	From front of set to screen (L3)	From rear of set to screen (L4)	From top of set to bottom edge of screen (A1)		From bottom of set to bottom edge of screen (A2)	
Diagonal image size (Inches)	Diagonal image size (m)	Height (SH)	Width (SW)	Projection distance (From mirror reflective surface to screen) (L1)				Min	Max	Min	Max
120	3.05	1.62	2.58	0.94	0.97	0.67	-0.06	0.24	0.33	0.57	0.65
150	3.81	2.02	3.23	1.18	1.20	0.90	0.17	0.33	0.44	0.66	0.77
200	5.08	2.69	4.31	1.56	1.59	1.28	0.56	0.49	0.63	0.81	0.96
250	6.35	3.37	5.38	1.95	1.97	1.67	0.94	0.64	0.82	0.97	1.15
300	7.62	4.04	6.46	2.33	2.36	2.05	1.33	0.80	1.01	1.12	1.34
350	8.89	4.71	7.54	2.72	2.74	2.44	1.71	0.95	1.21	1.27	1.53
400	10.16	5.38	8.62	3.10	3.13	2.82	2.10	1.11	1.40	1.43	1.72
500	12.70	6.73	10.77	3.87	3.90	3.59	2.87	1.41	1.78	1.74	2.10
600	15.24	8.08	12.92	4.64	4.67	4.36	3.64	1.72	2.16	2.05	2.48

Unit : feet

Ultra-short focal length lens ET-D75LE90 Close-up system dimensions											
Throw ratio				0.36:1	From tip of lens to screen (L2)	From front of set to screen (L3)	From rear of set to screen (L4)	From top of set to bottom edge of screen (A1)		From bottom of set to bottom edge of screen (A2)	
Diagonal image size (Inches)	Diagonal image size (m)	Height (SH)	Width (SW)	Projection distance (From mirror reflective surface to screen) (L1)				Min	Max	Min	Max
120	3.05	5.3	8.5	3.1	3.2	2.2	-0.2	0.8	1.1	1.9	2.1
150	3.81	6.6	10.6	3.9	3.9	2.9	0.6	1.1	1.5	2.2	2.5
200	5.08	8.8	14.1	5.1	5.2	4.2	1.8	1.6	2.1	2.7	3.1
250	6.35	11.0	17.7	6.4	6.5	5.5	3.1	2.1	2.7	3.2	3.8
300	7.62	13.2	21.2	7.6	7.7	6.7	4.4	2.6	3.3	3.7	4.4
350	8.89	15.5	24.7	8.9	9.0	8.0	5.6	3.1	4.0	4.2	5.0
400	10.16	17.7	28.3	10.2	10.3	9.3	6.9	3.6	4.6	4.7	5.6
500	12.70	22.1	35.3	12.7	12.8	11.8	9.4	4.6	5.8	5.7	6.9
600	15.24	26.5	42.4	15.2	15.3	14.3	11.9	5.6	7.1	6.7	8.1

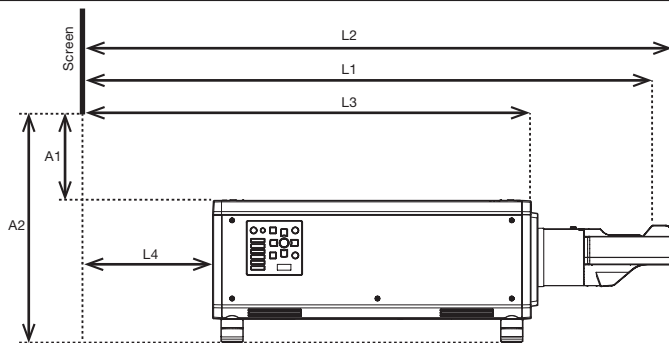

- L1: Projection distance (from screen to mirror reflective surface)
- L2: From screen to tip of lens
- L3: From screen to front of set
- L4: From screen to rear of set
- A1: From bottom edge of screen to top of set
- A2: From bottom edge of screen to bottom of set

Projection Distance Calculation Table

Screen aspect ratio 16:10

Projection distance calculation formula

$$L1 \text{ (m)} = 0.0077 \times \text{Diagonal image size (inches)} + 0.02$$

Calculation formula for distance from top of set to bottom edge of screen

RZ12K	Min. A1 (m) = 0.000229 × SH - 0.128 Max. A1 (m) = 0.000283 × SH - 0.128
-------	--

Fixed-Focus Lens

ET-D75LE90 Projection Distance Table

DZ13K/DZ10K

16 : 10 (WUXGA ; 1920 × 1200)

Unit : meters

Ultra-short focal length lens ET-D75LE90 Close-up system dimensions											
Throw ratio				0.36:1							
Diagonal image size (Inches)	Diagonal image size (m)	Height (SH)	Width (SW)	Projection distance (From mirror reflective surface to screen) (L1)	From tip of lens to screen (L2)	From front of set to screen (L3)	From rear of set to screen (L4)	From top of set to bottom edge of screen (A1)		From bottom of set to bottom edge of screen (A2)	
								Min	Max	Min	Max
120	3.05	1.62	2.59	0.94	0.97	0.67	0.13	0.27	0.36	0.47	0.56
150	3.81	2.02	3.23	1.18	1.20	0.90	0.36	0.36	0.47	0.56	0.67
200	5.08	2.69	4.31	1.56	1.59	1.28	0.74	0.52	0.66	0.72	0.86
250	6.35	3.37	5.39	1.95	1.97	1.67	1.13	0.67	0.85	0.87	1.05
300	7.62	4.04	6.46	2.33	2.36	2.05	1.51	0.83	1.04	1.03	1.24
350	8.89	4.71	7.54	2.72	2.74	2.44	1.90	0.98	1.23	1.18	1.43
400	10.16	5.39	8.62	3.10	3.13	2.82	2.28	1.13	1.42	1.33	1.62
500	12.70	6.73	10.77	3.87	3.90	3.59	3.05	1.44	1.81	1.64	2.01
600	15.24	8.08	12.92	4.64	4.67	4.36	3.82	1.75	2.19	1.95	2.39

Unit : feet

Ultra-short focal length lens ET-D75LE90 Close-up system dimensions											
Throw ratio				0.36:1							
Diagonal image size (Inches)	Diagonal image size (m)	Height (SH)	Width (SW)	Projection distance (From mirror reflective surface to screen) (L1)	From tip of lens to screen (L2)	From front of set to screen (L3)	From rear of set to screen (L4)	From top of set to bottom edge of screen (A1)		From bottom of set to bottom edge of screen (A2)	
								Min	Max	Min	Max
120	3.05	5.3	8.5	3.1	3.2	2.2	0.4	0.9	1.2	1.5	1.8
150	3.81	6.6	10.6	3.9	4.0	2.9	1.2	1.2	1.5	1.8	2.2
200	5.08	8.8	14.1	5.1	5.2	4.2	2.4	1.7	2.2	2.4	2.8
250	6.35	11.0	17.7	6.4	6.5	5.5	3.7	2.2	2.8	2.9	3.5
300	7.62	13.3	21.2	7.6	7.7	6.7	5.0	2.7	3.4	3.4	4.1
350	8.89	15.5	24.7	8.9	9.0	8.0	6.2	3.2	4.0	3.9	4.7
400	10.16	17.7	28.3	10.2	10.3	9.3	7.5	3.7	4.7	4.4	5.3
500	12.70	22.1	35.3	12.7	12.8	11.8	10.0	4.7	5.9	5.4	6.6
600	15.24	26.5	42.4	15.2	15.3	14.3	12.5	5.7	7.2	6.4	7.8

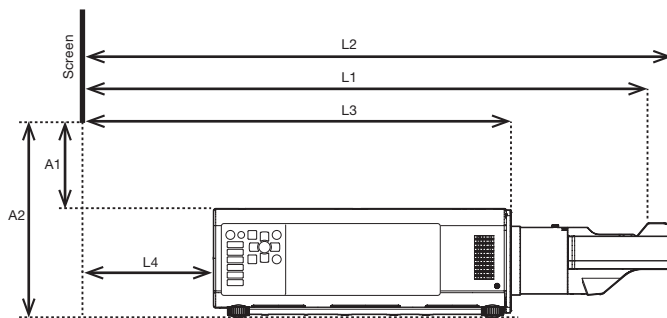

- L1: Projection distance (from screen to mirror reflective surface)
- L2: From screen to tip of lens
- L3: From screen to front of set
- L4: From screen to rear of set
- A1: From bottom edge of screen to top of set
- A2: From bottom edge of screen to bottom of set

Projection Distance Calculation Table

Screen aspect ratio 16:10

Projection distance calculation formula

$$L1 \text{ (m)} = 0.0077 \times \text{Diagonal image size (inches)} + 0.02$$

Calculation formula for distance from top of set to bottom edge of screen

DZ13K/DZ10K	Min. A1 (m) = 0.000229 × SH - 0.100 Max. A1 (m) = 0.000283 × SH - 0.100
-------------	--

Fixed-Focus Lens

ET-D75LE90 Projection Distance Table

DZ16K/DZ16K2

16 : 9 (WXGA ; 1920 × 1080)

Unit : meters

Throw ratio				Ultra-short focal length lens ET-D75LE90 Close-up system dimensions							
Diagonal image size (Inches)	Diagonal image size (m)	Height (SH)	Width (SW)	Projection distance (From mirror reflective surface to screen) (L1)	From tip of lens to screen (L2)	From front of set to screen (L3)	From rear of set to screen (L4)	From top of set to bottom edge of screen (A1)		From bottom of set to bottom edge of screen (A2)	
								Min	Max	Min	Max
120	3.05	1.49	2.66	0.97	1.00	0.69	-0.04	0.27	0.44	0.56	0.73
150	3.81	1.87	3.32	1.21	1.24	0.93	0.20	0.36	0.58	0.65	0.87
200	5.08	2.49	4.43	1.60	1.63	1.33	0.60	0.52	0.81	0.81	1.10
250	6.35	3.11	5.54	2.00	2.03	1.72	0.99	0.68	1.04	0.97	1.33
300	7.62	3.74	6.64	2.39	2.42	2.12	1.39	0.83	1.27	1.13	1.56
350	8.89	4.36	7.75	2.79	2.82	2.51	1.78	0.99	1.50	1.28	1.79
400	10.16	4.98	8.86	3.19	3.21	2.91	2.18	1.15	1.73	1.44	2.02
500	12.70	6.23	11.07	3.98	4.01	3.70	2.97	1.47	2.19	1.76	2.48
600	15.24	7.47	13.28	4.77	4.80	4.49	3.76	1.78	2.65	2.08	2.94

Unit : feet

Throw ratio				Ultra-short focal length lens ET-D75LE90 Close-up system dimensions							
Diagonal image size (Inches)	Diagonal image size (m)	Height (SH)	Width (SW)	Projection distance (From mirror reflective surface to screen) (L1)	From tip of lens to screen (L2)	From front of set to screen (L3)	From rear of set to screen (L4)	From top of set to bottom edge of screen (A1)		From bottom of set to bottom edge of screen (A2)	
								Min	Max	Min	Max
120	3.05	4.9	8.7	3.2	3.3	2.3	-0.1	0.9	1.4	1.8	2.4
150	3.81	6.1	10.9	4.0	4.1	3.1	0.7	1.2	1.9	2.1	2.8
200	5.08	8.2	14.5	5.3	5.4	4.3	2.0	1.7	2.6	2.7	3.6
250	6.35	10.2	18.2	6.6	6.7	5.6	3.3	2.2	3.4	3.2	4.4
300	7.62	12.3	21.8	7.9	7.9	6.9	4.6	2.7	4.2	3.7	5.1
350	8.89	14.3	25.4	9.2	9.2	8.2	5.8	3.3	4.9	4.2	5.9
400	10.16	16.3	29.1	10.5	10.5	9.5	7.1	3.8	5.7	4.7	6.6
500	12.70	20.4	36.3	13.0	13.1	12.1	9.7	4.8	7.2	5.8	8.1
600	15.24	24.5	43.6	15.6	15.7	14.7	12.3	5.9	8.7	6.8	9.7

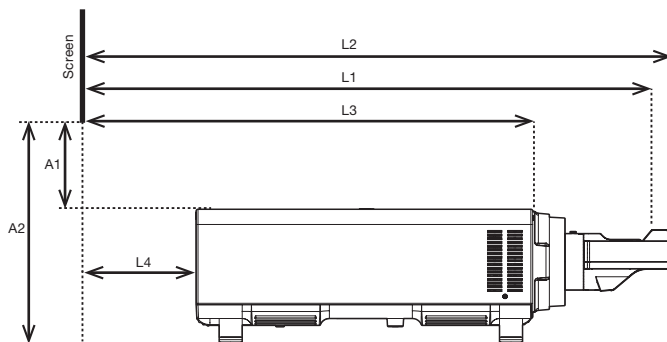

- L1: Projection distance (from screen to mirror reflective surface)
- L2: From screen to tip of lens
- L3: From screen to front of set
- L4: From screen to rear of set
- A1: From bottom edge of screen to top of set
- A2: From bottom edge of screen to bottom of set

Projection Distance Calculation Table

Screen aspect ratio 16:9

Projection distance calculation formula

$$L1 (m) = 0.007914 \times \text{Diagonal image size (inches)} + 0.02$$

Calculation formula for distance from top of set to bottom edge of screen

DZ16K/DZ16K2	Min. A1 (m) = 0.000254 × SH - 0.114 Max. A1 (m) = 0.000370 × SH - 0.114
--------------	--

Fixed-Focus Lens

ET-D75LE90 Projection Distance Table

DW17K/DW17K2

16 : 9 (WXGA ; 1366 × 768)

Unit : meters

Throw ratio				Ultra-short focal length lens ET-D75LE90 Close-up system dimensions							
Diagonal image size (Inches)	Diagonal image size (m)	Height (SH)	Width (SW)	Projection distance (From mirror reflective surface to screen) (L1)	From tip of lens to screen (L2)	From front of set to screen (L3)	From rear of set to screen (L4)	From top of set to bottom edge of screen (A1)		From bottom of set to bottom edge of screen (A2)	
								Min	Max	Min	Max
120	3.05	1.49	2.66	1.07	1.10	0.80	0.07	0.31	0.58	0.60	0.87
150	3.81	1.87	3.32	1.34	1.37	1.06	0.33	0.41	0.76	0.70	1.05
200	5.08	2.49	4.43	1.78	1.81	1.50	0.77	0.59	1.05	0.88	1.34
250	6.35	3.11	5.54	2.22	2.24	1.94	1.21	0.76	1.34	1.06	1.63
300	7.62	3.74	6.64	2.66	2.68	2.38	1.65	0.94	1.63	1.23	1.92
350	8.89	4.36	7.75	3.09	3.12	2.82	2.09	1.12	1.92	1.41	2.21
400	10.16	4.98	8.86	3.53	3.56	3.26	2.53	1.29	2.21	1.58	2.50
500	12.70	6.23	11.07	4.41	4.44	4.13	3.40	1.64	2.79	1.93	3.08
600	15.24	7.47	13.28	5.29	5.32	5.01	4.28	1.99	3.37	2.28	3.66

Unit : feet

Throw ratio				Ultra-short focal length lens ET-D75LE90 Close-up system dimensions							
Diagonal image size (Inches)	Diagonal image size (m)	Height (SH)	Width (SW)	Projection distance (From mirror reflective surface to screen) (L1)	From tip of lens to screen (L2)	From front of set to screen (L3)	From rear of set to screen (L4)	From top of set to bottom edge of screen (A1)		From bottom of set to bottom edge of screen (A2)	
								Min	Max	Min	Max
120	3.05	4.9	8.7	3.5	3.6	2.6	0.2	1.0	1.9	2.0	2.9
150	3.81	6.1	10.9	4.4	4.5	3.5	1.1	1.4	2.5	2.3	3.4
200	5.08	8.2	14.5	5.8	5.9	4.9	2.5	1.9	3.4	2.9	4.4
250	6.35	10.2	18.2	7.3	7.4	6.4	4.0	2.5	4.4	3.5	5.3
300	7.62	12.3	21.8	8.7	8.8	7.8	5.4	3.1	5.3	4.0	6.3
350	8.89	14.3	25.4	10.2	10.2	9.2	6.8	3.7	6.3	4.6	7.2
400	10.16	16.3	29.1	11.6	11.7	10.7	8.3	4.2	7.2	5.2	8.2
500	12.70	20.4	36.3	14.5	14.6	13.6	11.2	5.4	9.1	6.3	10.1
600	15.24	24.5	43.6	17.4	17.4	16.4	14.0	6.5	11.0	7.5	12.0

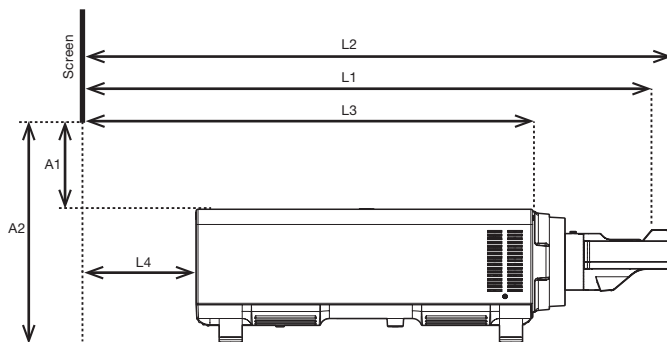

- L1: Projection distance (from screen to mirror reflective surface)
- L2: From screen to tip of lens
- L3: From screen to front of set
- L4: From screen to rear of set
- A1: From bottom edge of screen to top of set
- A2: From bottom edge of screen to bottom of set

Projection Distance Calculation Table

Screen aspect ratio 16:9

Projection distance calculation formula

$$L1 (m) = 0.008783 \times \text{Diagonal image size (inches)} + 0.02$$

Calculation formula for distance from top of set to bottom edge of screen

DW17K/DW17K2	Min. A1 (m) = 0.000282 x SH - 0.114 Max. A1 (m) = 0.000466 x SH - 0.114
--------------	--

Fixed-Focus Lens

ET-D75LE90 Projection Distance Table

DW11K

16 : 9 (WXGA ; 1366 × 768)

Unit : meters

Throw ratio				Ultra-short focal length lens ET-D75LE90 Close-up system dimensions							
Diagonal image size (Inches)	Diagonal image size (m)	Height (SH)	Width (SW)	Projection distance (From mirror reflective surface to screen) (L1)	From tip of lens to screen (L2)	From front of set to screen (L3)	From rear of set to screen (L4)	From top of set to bottom edge of screen (A1)		From bottom of set to bottom edge of screen (A2)	
								Min	Max	Min	Max
120	3.05	1.49	2.66	1.07	1.10	0.80	0.26	0.32	0.60	0.52	0.80
150	3.81	1.87	3.32	1.34	1.37	1.06	0.52	0.43	0.77	0.63	0.97
200	5.08	2.49	4.43	1.78	1.81	1.50	0.96	0.60	1.06	0.80	1.26
250	6.35	3.11	5.54	2.22	2.24	1.94	1.40	0.78	1.35	0.98	1.55
300	7.62	3.74	6.64	2.66	2.68	2.38	1.84	0.95	1.64	1.15	1.84
350	8.89	4.36	7.75	3.09	3.12	2.82	2.28	1.13	1.93	1.33	2.13
400	10.16	4.98	8.86	3.53	3.56	3.26	2.72	1.31	2.22	1.51	2.42
500	12.70	6.23	11.07	4.41	4.44	4.13	3.59	1.66	2.80	1.86	3.00
600	15.24	7.47	13.28	5.29	5.32	5.01	4.47	2.01	3.38	2.21	3.58

Unit : feet

Throw ratio				Ultra-short focal length lens ET-D75LE90 Close-up system dimensions							
Diagonal image size (Inches)	Diagonal image size (m)	Height (SH)	Width (SW)	Projection distance (From mirror reflective surface to screen) (L1)	From tip of lens to screen (L2)	From front of set to screen (L3)	From rear of set to screen (L4)	From top of set to bottom edge of screen (A1)		From bottom of set to bottom edge of screen (A2)	
								Min	Max	Min	Max
120	3.05	4.9	8.7	3.5	3.6	2.6	0.8	1.1	2.0	1.7	2.6
150	3.81	6.1	10.9	4.4	4.5	3.5	1.7	1.4	2.5	2.1	3.2
200	5.08	8.2	14.5	5.8	5.9	4.9	3.1	2.0	3.5	2.6	4.1
250	6.35	10.2	18.2	7.3	7.4	6.4	4.6	2.6	4.4	3.2	5.1
300	7.62	12.3	21.8	8.7	8.8	7.8	6.0	3.1	5.4	3.8	6.0
350	8.89	14.3	25.4	10.2	10.2	9.2	7.5	3.7	6.3	4.4	7.0
400	10.16	16.3	29.1	11.6	11.7	10.7	8.9	4.3	7.3	4.9	7.9
500	12.70	20.4	36.3	14.5	14.6	13.6	11.8	5.4	9.2	6.1	9.8
600	15.24	24.5	43.6	17.4	17.4	16.4	14.7	6.6	11.1	7.2	11.8

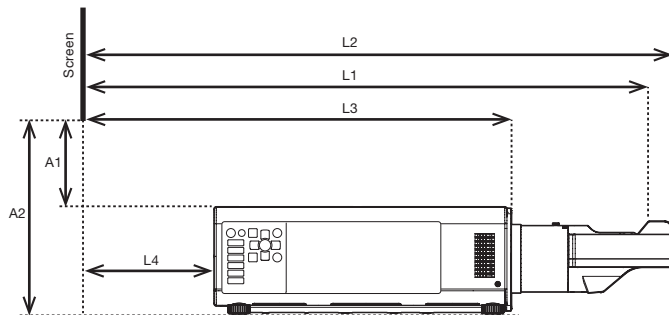

- L1: Projection distance (from screen to mirror reflective surface)
- L2: From screen to tip of lens
- L3: From screen to front of set
- L4: From screen to rear of set
- A1: From bottom edge of screen to top of set
- A2: From bottom edge of screen to bottom of set

Projection Distance Calculation Table

Screen aspect ratio 16:9

Projection distance calculation formula

$$L1 \text{ (m)} = 0.008783 \times \text{Diagonal image size (inches)} + 0.02$$

Calculation formula for distance from top of set to bottom edge of screen

DW11K	Min. A1 (m) = 0.000282 x SH - 0.100 Max. A1 (m) = 0.000466 x SH - 0.100
-------	--

ET-D75LE90 Projection Distance Table

DS20K/DS20K2

4 : 3 (SXGA ; 1400 × 1050)

Unit : meters

Ultra-short focal length lens ET-D75LE90
Close-up system dimensions

Throw ratio		0.39:1			From tip of lens to screen (L2)	From front of set to screen (L3)	From rear of set to screen (L4)	From top of set to bottom edge of screen (A1)	From bottom of set to bottom edge of screen (A2)
Diagonal image size (Inches)	Diagonal image size (m)	Height (SH)	Width (SW)	Projection distance (From mirror reflective surface to screen) (L1)					
120	3.05	1.83	2.44	0.96	0.99	0.69	-0.04	0.26	0.55
150	3.81	2.29	3.05	1.20	1.23	0.92	0.19	0.36	0.65
200	5.08	3.05	4.06	1.59	1.62	1.32	0.59	0.51	0.81
250	6.35	3.81	5.08	1.99	2.02	1.71	0.98	0.67	0.96
300	7.62	4.57	6.10	2.38	2.41	2.10	1.37	0.83	1.12
350	8.89	5.33	7.11	2.77	2.80	2.50	1.77	0.99	1.28
400	10.16	6.10	8.13	3.17	3.20	2.89	2.16	1.14	1.43
500	12.70	7.62	10.16	3.95	3.98	3.68	2.95	1.46	1.75
600	15.24	9.14	12.19	4.74	4.77	4.46	3.73	1.77	2.06

Unit : feet

Ultra-short focal length lens ET-D75LE90
Close-up system dimensions

Throw ratio		0.39:1			From tip of lens to screen (L2)	From front of set to screen (L3)	From rear of set to screen (L4)	From top of set to bottom edge of screen (A1)	From bottom of set to bottom edge of screen (A2)
Diagonal image size (Inches)	Diagonal image size (m)	Height (SH)	Width (SW)	Projection distance (From mirror reflective surface to screen) (L1)					
120	3.05	6.0	8.0	3.2	3.3	2.3	-0.1	0.9	1.8
150	3.81	7.5	10.0	3.9	4.0	3.0	0.6	1.2	2.1
200	5.08	10.0	13.3	5.2	5.3	4.3	1.9	1.7	2.6
250	6.35	12.5	16.7	6.5	6.6	5.6	3.2	2.2	3.2
300	7.62	15.0	20.0	7.8	7.9	6.9	4.5	2.7	3.7
350	8.89	17.5	23.3	9.1	9.2	8.2	5.8	3.2	4.2
400	10.16	20.0	26.7	10.4	10.5	9.5	7.1	3.7	4.7
500	12.70	25.0	33.3	13.0	13.1	12.1	9.7	4.8	5.7
600	15.24	30.0	40.0	15.5	15.6	14.6	12.2	5.8	6.8

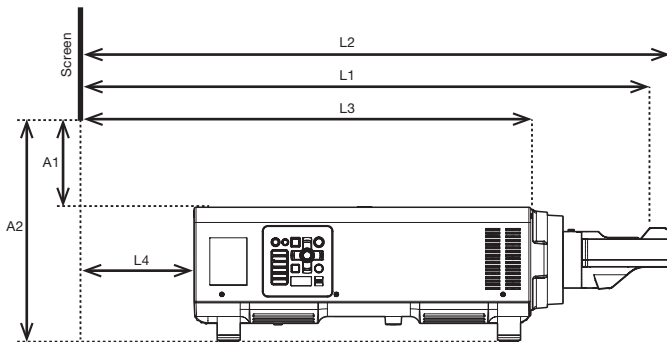

- L1: Projection distance (from screen to mirror reflective surface)
- L2: From screen to tip of lens
- L3: From screen to front of set
- L4: From screen to rear of set
- A1: From bottom edge of screen to top of set
- A2: From bottom edge of screen to bottom of set

Projection Distance Calculation Table

Screen aspect ratio 4:3

Projection distance calculation formula

$$L1 (m) = 0.007865 \times \text{Diagonal image size (inches)} + 0.02$$

Calculation formula for distance from top of set to bottom edge of screen

DS20K/DS20K2	$A1 (m) = 0.000206 \times SH - 0.114$
--------------	---------------------------------------

Fixed-Focus Lens

ET-D75LE90 Projection Distance Table

DS12K

4 : 3 (SXGA ; 1400 × 1050)

Unit : meters

Ultra-short focal length lens ET-D75LE90
Close-up system dimensions

Throw ratio				0.39:1					
Diagonal image size (Inches)	Diagonal image size (m)	Height (SH)	Width (SW)	Projection distance (From mirror reflective surface to screen) (L1)	From tip of lens to screen (L2)	From front of set to screen (L3)	From rear of set to screen (L4)	From top of set to bottom edge of screen (A1)	From bottom of set to bottom edge of screen (A2)
120	3.05	1.83	2.44	0.96	0.99	0.69	0.15	0.28	0.48
150	3.81	2.29	3.05	1.20	1.23	0.92	0.38	0.37	0.57
200	5.08	3.05	4.06	1.59	1.62	1.32	0.78	0.53	0.73
250	6.35	3.81	5.08	1.99	2.02	1.71	1.17	0.68	0.88
300	7.62	4.57	6.10	2.38	2.41	2.10	1.56	0.84	1.04
350	8.89	5.33	7.11	2.77	2.80	2.50	1.96	1.00	1.20
400	10.16	6.10	8.13	3.17	3.20	2.89	2.35	1.16	1.36
500	12.70	7.62	10.16	3.95	3.98	3.68	3.14	1.47	1.67
600	15.24	9.14	12.19	4.74	4.77	4.46	3.92	1.78	1.98

Unit : feet

Ultra-short focal length lens ET-D75LE90
Close-up system dimensions

Throw ratio				0.39:1					
Diagonal image size (Inches)	Diagonal image size (m)	Height (SH)	Width (SW)	Projection distance (From mirror reflective surface to screen) (L1)	From tip of lens to screen (L2)	From front of set to screen (L3)	From rear of set to screen (L4)	From top of set to bottom edge of screen (A1)	From bottom of set to bottom edge of screen (A2)
120	3.05	6.0	8.0	3.2	3.3	2.3	0.5	0.9	1.6
150	3.81	7.5	10.0	3.9	4.0	3.0	1.3	1.2	1.9
200	5.08	10.0	13.3	5.2	5.3	4.3	2.5	1.7	2.4
250	6.35	12.5	16.7	6.5	6.6	5.6	3.8	2.2	2.9
300	7.62	15.0	20.0	7.8	7.9	6.9	5.1	2.8	3.4
350	8.89	17.5	23.3	9.1	9.2	8.2	6.4	3.3	3.9
400	10.16	20.0	26.7	10.4	10.5	9.5	7.7	3.8	4.4
500	12.70	25.0	33.3	13.0	13.1	12.1	10.3	4.8	5.5
600	15.24	30.0	40.0	15.5	15.6	14.6	12.9	5.9	6.5

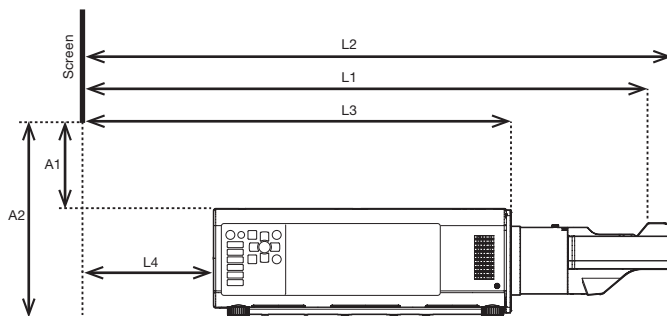

- L1: Projection distance (from screen to mirror reflective surface)
- L2: From screen to tip of lens
- L3: From screen to front of set
- L4: From screen to rear of set
- A1: From bottom edge of screen to top of set
- A2: From bottom edge of screen to bottom of set

Projection Distance Calculation Table

Screen aspect ratio 4:3

Projection distance calculation formula

$L1 (m) = 0.007865 \times \text{Diagonal image size (inches)} + 0.02$

Calculation formula for distance from top of set to bottom edge of screen

DS12K	$A1 (m) = 0.000206 \times SH - 0.100$
-------	---------------------------------------

Fixed-Focus Lens

ET-D75LE90 Projection Distance Table

RS11K

4 : 3 (SXGA ; 1400 × 1050)

Unit : meters

Ultra-short focal length lens ET-D75LE90
Close-up system dimensions

Throw ratio				0.39:1						
Diagonal image size (Inches)	Diagonal image size (m)	Height (SH)	Width (SW)	Projection distance (From mirror reflective surface to screen) (L1)	From tip of lens to screen (L2)	From front of set to screen (L3)	From rear of set to screen (L4)	From top of set to bottom edge of screen (A1)	From bottom of set to bottom edge of screen (A2)	
120	3.05	1.83	2.44	0.96	0.99	0.69	-0.04	0.25	0.57	
150	3.81	2.29	3.05	1.20	1.23	0.92	0.20	0.34	0.67	
200	5.08	3.05	4.06	1.59	1.62	1.32	0.59	0.50	0.82	
250	6.35	3.81	5.08	1.99	2.01	1.71	0.98	0.66	0.98	
300	7.62	4.57	6.10	2.38	2.41	2.10	1.38	0.81	1.14	
350	8.89	5.33	7.11	2.77	2.80	2.50	1.77	0.97	1.29	
400	10.16	6.10	8.13	3.17	3.19	2.89	2.16	1.13	1.45	
500	12.70	7.62	10.16	3.95	3.98	3.68	2.95	1.44	1.77	
600	15.24	9.14	12.19	4.74	4.77	4.46	3.74	1.76	2.08	

Unit : feet

Ultra-short focal length lens ET-D75LE90
Close-up system dimensions

Throw ratio				0.39:1						
Diagonal image size (Inches)	Diagonal image size (m)	Height (SH)	Width (SW)	Projection distance (From mirror reflective surface to screen) (L1)	From tip of lens to screen (L2)	From front of set to screen (L3)	From rear of set to screen (L4)	From top of set to bottom edge of screen (A1)	From bottom of set to bottom edge of screen (A2)	
120	3.05	6.0	8.0	3.2	3.3	2.3	-0.1	0.8	1.9	
150	3.81	7.5	10.0	3.9	4.0	3.0	0.6	1.1	2.2	
200	5.08	10.0	13.3	5.2	5.3	4.3	1.9	1.6	2.7	
250	6.35	12.5	16.7	6.5	6.6	5.6	3.2	2.2	3.2	
300	7.62	15.0	20.0	7.8	7.9	6.9	4.5	2.7	3.7	
350	8.89	17.5	23.3	9.1	9.2	8.2	5.8	3.2	4.2	
400	10.16	20.0	26.7	10.4	10.5	9.5	7.1	3.7	4.8	
500	12.70	25.0	33.3	13.0	13.1	12.1	9.7	4.7	5.8	
600	15.24	30.0	40.0	15.5	15.6	14.6	12.3	5.8	6.8	

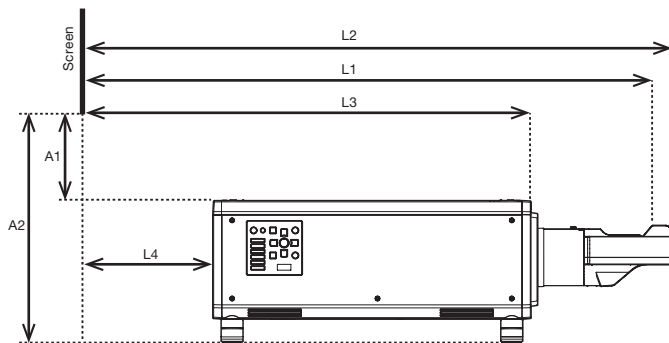

- L1: Projection distance (from screen to mirror reflective surface)
- L2: From screen to tip of lens
- L3: From screen to front of set
- L4: From screen to rear of set
- A1: From bottom edge of screen to top of set
- A2: From bottom edge of screen to bottom of set

Projection Distance Calculation Table

Screen aspect ratio 4:3

Projection distance calculation formula

$$L1 (m) = 0.007865 \times \text{Diagonal image size (inches)} + 0.02$$

Calculation formula for distance from top of set to bottom edge of screen

RS11K	$A1 (m) = 0.000206 \times SH - 0.128$
-------	---------------------------------------